

Article number: 07117050001

Description: Universal joint single 0.117.050.001
S=184 X= Bore with keyway

Measures

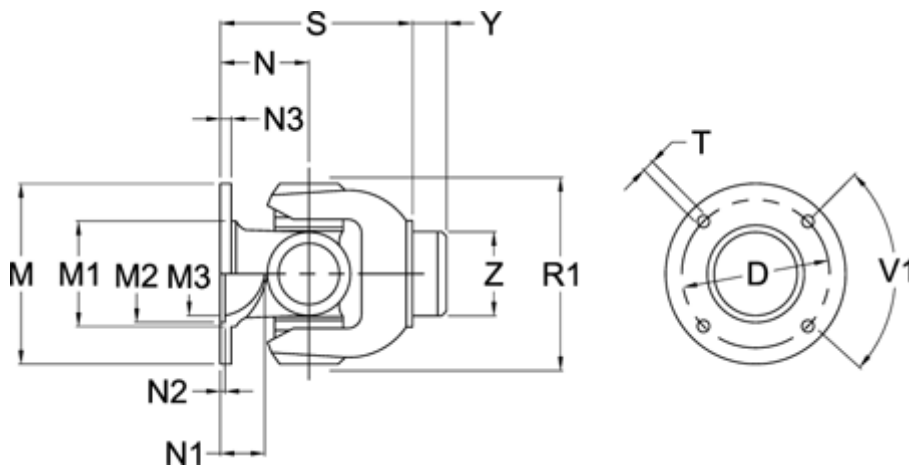

D	= 130 +0,1	N2	= 3 +0,5	Z = 90.25
Flange diameter M	= 150	N3	= 12	
M1	= 104	Number og Flangeholes	= 12	
M2	= 90	R1	= 158	
M3	= 85	S min	= 184	
Max. Bending Angle degrees	= 30	T	= 12 B12	
N	= 86	V1 degrees	= 30	
N1	= 29	Y	= 28	